

323F L

Hydraulic Excavator

2017



Engine

Engine Model	Cat® C7.1 ACERT™	
Gross Power – SAE J1995/ISO 14396	122 kW	164 hp
Net Power – SAE J1349/ISO 9249	120 kW	161 hp

Drive

Maximum Travel Speed	5.5 km/h	3.4 mph
Maximum Drawbar Pull	205 kN	46,090 lbf

Weight

Operating Weight (ANZ)	25 000 kg	55,100 lb
Operating Weight (ADSD-N)	23 100 kg	50,900 lb

Introduction

The Cat 323FL is a purpose-built machine powered by a fuel-efficient C7.1 ACERT engine that meets U.S. EPA Tier 4 Final and EU Stage IV emission standards. With plenty of counterweight, robust structures, a state-of-the-art hydraulic system, and Cat Grade Control Depth and Slope you can move tons of material – literally – all day long with tremendous stability, speed, and precision. Available Cat Grade Assist will even do some of the work for you.*

When you add in a quiet operator environment that keeps you comfortable and productive, easy-to-reach service points that make your routine maintenance fast and simple, and multiple Cat work tools that help you take on a variety of tasks, you just won't find a better, more efficient 23-ton excavator – any place, anywhere.

Bottom line: If you are in the business of road construction, underground utilities, or commercial and residential site development, you need the versatile Cat 323FL in your fleet.

**Cat Grade Control Depth and Slope hardware is standard with R2.9 (9'6") sticks. See pages 4 and 5 for more details.*

Contents

Cat Connect Technologies.....	4
Engine	6
Hydraulics	8
Heavy Configuration	10
Operator Station.....	11
Front Linkage	12
Structures & Undercarriage	13
Attachments.....	14
Serviceability.....	16
Safety	17
Complete Customer Care.....	18
Sustainability	19
Specifications.....	20
Standard Equipment.....	34
Optional Equipment.....	35







Cat Connect Technologies

Monitor, manage, and enhance your job site operations

Cat CONNECT makes smart use of technology and services to improve your job site efficiency. Using the data from technology-equipped machines, you'll get more information and insight into your equipment and operations than ever before.

Cat Connect technologies offer improvements in these key areas:



EQUIPMENT
MANAGEMENT

Equipment Management – increase uptime and reduce operating costs.



PRODUCTIVITY

Productivity – monitor production and manage job site efficiency.



SAFETY

Safety – enhance job site awareness to keep your people and equipment safe.



LINK Technologies

LINK technologies like Product Link™ are deeply integrated into your machine and wirelessly communicate key information, including location, hours, fuel usage, idle time, and event codes.

Product Link/VisionLink®

Easy access to Product Link data via the online VisionLink user interface can help you see how your machine or fleet is performing. You can use this information to make timely, fact-based decisions that can boost job site efficiency and productivity and lower costs.

Cat GRADE with ASSIST Tilt Bucket Capability (ADSD-N only)

Cat GRADE with ASSIST helps operators of all skill levels dig a level base with the right slope each and every time, and now it works with tilt buckets. With a touch of a button, the simple-to-use system automates boom and bucket movements to help operators reach target grade up to 45% faster than using traditional techniques.

Cat Grade Control Depth and Slope

The factory-integrated Cat Grade Control system, standard on the 323F with R2.9 (9'6") stick, delivers 2D bucket tip elevation guidance to the cab to help operators create precise planes and slopes with ease. Real-time bucket tip elevation guidance on the easy-to-read standard cab monitor indicates how much to cut or fill. Fast response sensors deliver immediate feedback. Integrated joystick buttons help operators make quick adjustments to maintain consistent, quality grades. Built-in alerts can be set to warn the operator if the linkage or bucket approaches a predefined elevation or depth like when working in areas with low ceilings or digging near water lines. Staking and checking is minimized, which reduces ground crews and enhances job site safety. The system works best in simple 2D applications such as digging basements or grading steep embankments. You can easily upgrade to AccuGrade™ when 3D control is required.

Cat AccuGrade

The dealer-installed AccuGrade system provides 3D guidance for making complex cuts and contours, eliminating the need for staking and checking. A dedicated monitor displays a digital design plan with 3D bucket tip positioning and elevation guidance, indicating precisely where to work and how much to cut or fill. The plug-and-play capability on the 323F L simplifies upgrading. Choose from satellite (GNSS) control for large projects with complex designs or total station (UTS) systems in areas with limited reception.

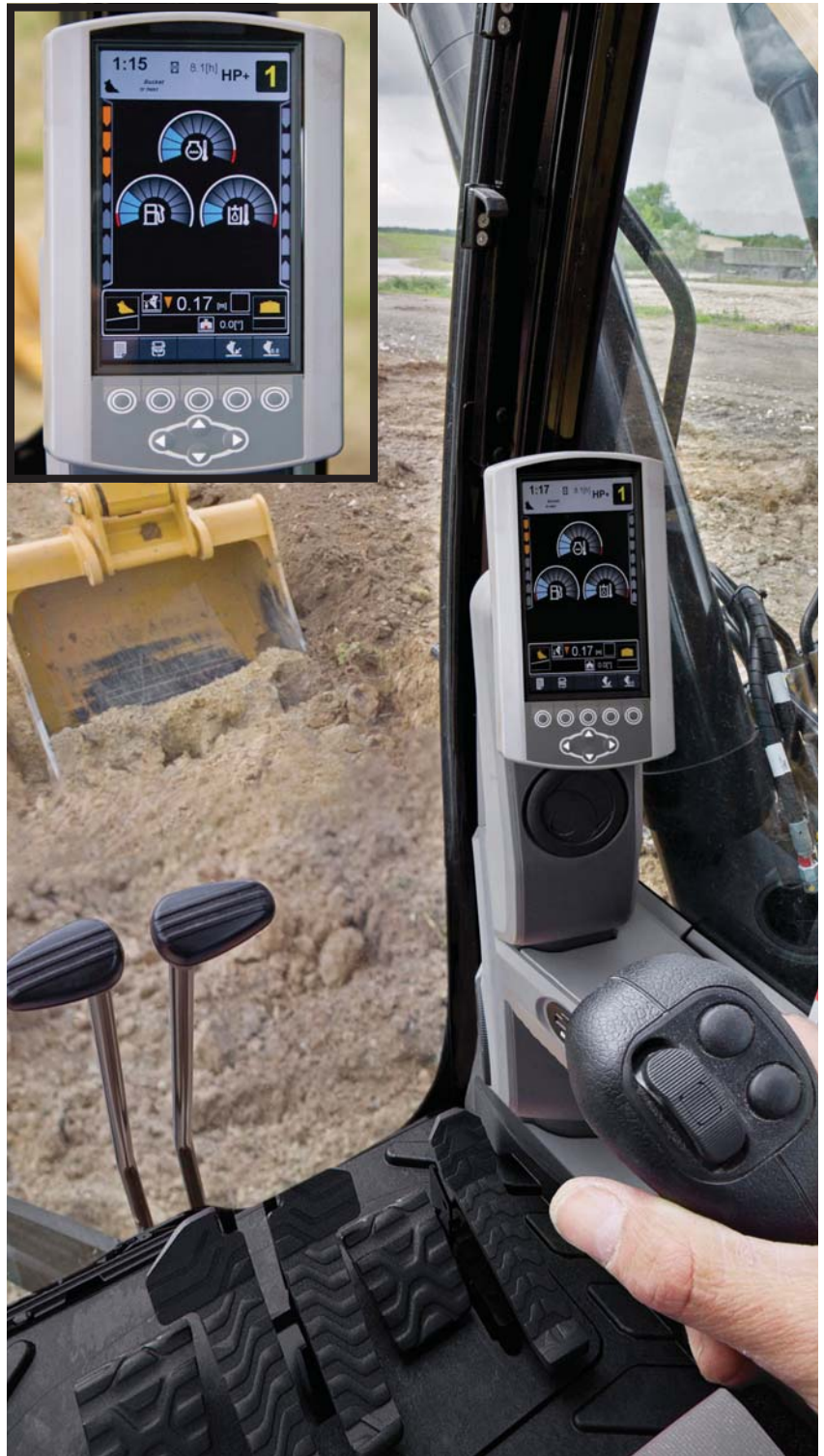

Engine

Powerful and fuel efficient to meet your expectations

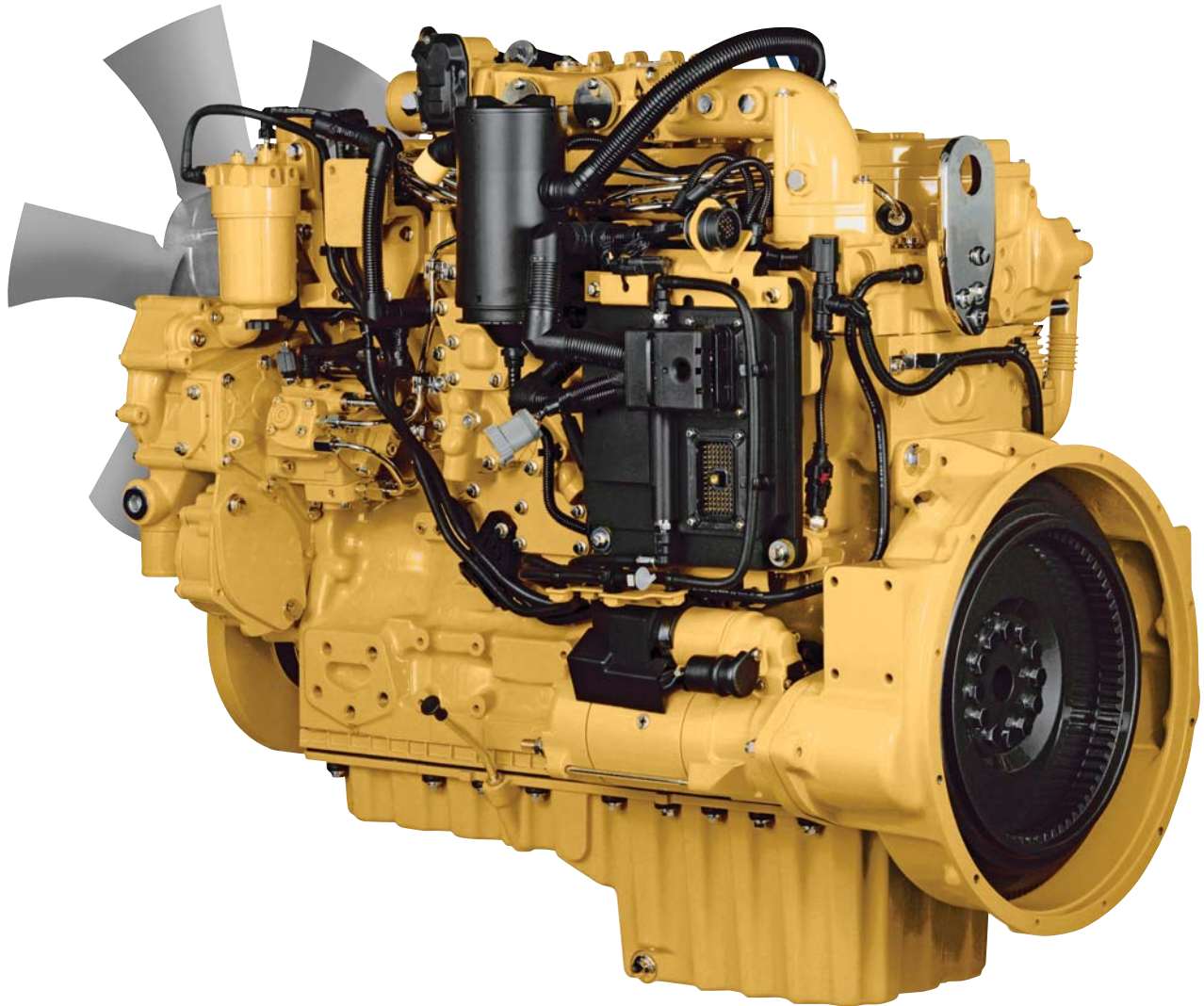

Proven Technology

Every Tier 4 Final/Stage IV ACERT engine is equipped with a combination of proven electronic, fuel, air, and aftertreatment components. Applying these time-tested technologies lets us meet your high expectations for productivity, fuel efficiency, reliability, and service life. Following are the results you can expect:

- **Improved fluid efficiency of up to 5%** over Tier 4 Interim/Stage IIIB products, including Diesel Exhaust Fluid (DEF) consumption.
- **High performance** across a variety of applications.
- **Enhanced reliability** through commonality and simplicity of design.
- **Maximized uptime and reduced cost** with world-class Cat dealer support.
- **Minimized impact** on emission systems – with no operator interaction required.
- **Durability** with long service life.
- **Better fuel economy** with minimized maintenance costs.
- **Same great power** and response.

More Powerful, Reliable Engine Electronics

Cat Tier 4 Final/Stage IV engine electronics are more powerful and robust than ever, enhancing your experience and increasing quality and reliability through the most demanding applications.

Next Generation Fuel Systems

Injection timing precisely controls the fuel injection process, which provides more control of combustion for the cleanest, most efficient fuel burn. To maximize your value, Caterpillar engineers specified fuel systems based on the power and performance demands for each engine. The high-pressure common rail fuel system with full electronic injection improves precision and control, reducing soot and boosting the engine's performance.

Innovative Air Management

Cat Tier 4 Final/Stage IV engines feature innovative air management systems that optimize airflow and enhance power, efficiency, and reliability. A range of simple, reliable turbocharging solutions based on engine size and application allows us to match turbo performance to rated output for high productivity, excellent fuel efficiency, long life, and low operating costs for you.

Cat NO_x Reduction System

The Cat NO_x Reduction System captures and cools a small quantity of exhaust gas and then routes it back into the combustion chamber to drive down temperatures and reduce NO_x emissions. The result of more than a decade of Caterpillar engineering research into this technology is the most reliable system of its type.

Aftertreatment Technologies

Caterpillar designed Tier 4 Interim/Stage IIIB products with Tier 4 Final/Stage IV emission standards in mind. By planning ahead, we minimized design changes to deliver the reliability and performance you demand. The aftertreatment solution utilized for Tier 4 Final/Stage IV products is the next evolutionary step for Cat engines with ACERT Technology. To meet the additional 80% reduction in NO_x emissions required by Tier 4 Final/Stage IV emission standards, Caterpillar engineers only needed to add one new system to the already proven aftertreatment solution in use, Selective Catalytic Reduction (SCR).

Diesel Exhaust Fluid (DEF)

Cat engines equipped with an SCR system inject DEF into the exhaust to reduce NO_x emissions. DEF is a precisely mixed solution of 32.5% high purity chemical grade urea and 67.5% de-ionized water. DEF used in Cat SCR systems must meet the requirements outlined in the International Organization for Standardization (ISO) standard 22241-1. ISO 22241-1 requirements are met by many brands of DEF, including those that carry the AdBlue or API certifications.

An Emissions Solution That Works

The Cat C7.1 ACERT engine meets Tier 4 Final/Stage IV emission standards, and it does so without interrupting your job process. In fact, the engine's diesel particulate filter is maintenance free. Simply turn the engine on and go to work.

Fuel Savers That Add Up

The 323F L consumes up to 10% less fuel than the previous series model, and lowering engine speed without impacting production is one of the key contributors. Automatic engine speed control also contributes by lowering rpm when the machine doesn't need it for work. Automatic engine idle shutdown turns the engine off when it's been idling for more than a specified amount of time that you can set through the monitor. Plus you have a choice of three power modes – high power, standard power, and eco mode. Simply change between modes through the console switch panel to meet the work needs in front of you. Collectively, all of these benefits add up to reduced fuel consumption, reduced exhaust and sound emissions, reduced repair and maintenance costs, and increased engine life for you.

A Cool Design For Any Temperature

A side-by-side cooling system allows you to put the machine to work in extremely hot and cold conditions. The system is completely separated from the engine compartment to reduce noise and heat. Plus it features easy-to-clean cores and a variable-speed fan that runs only when needed to ensure maximum efficiency.

Biodiesel Not A Problem

The C7.1 ACERT engine can run on up to B20 biodiesel that meets ASTM 6751 standards – all to give you more potential fuel-saving flexibility.

Hydraulics

Power to move your material with speed and precision

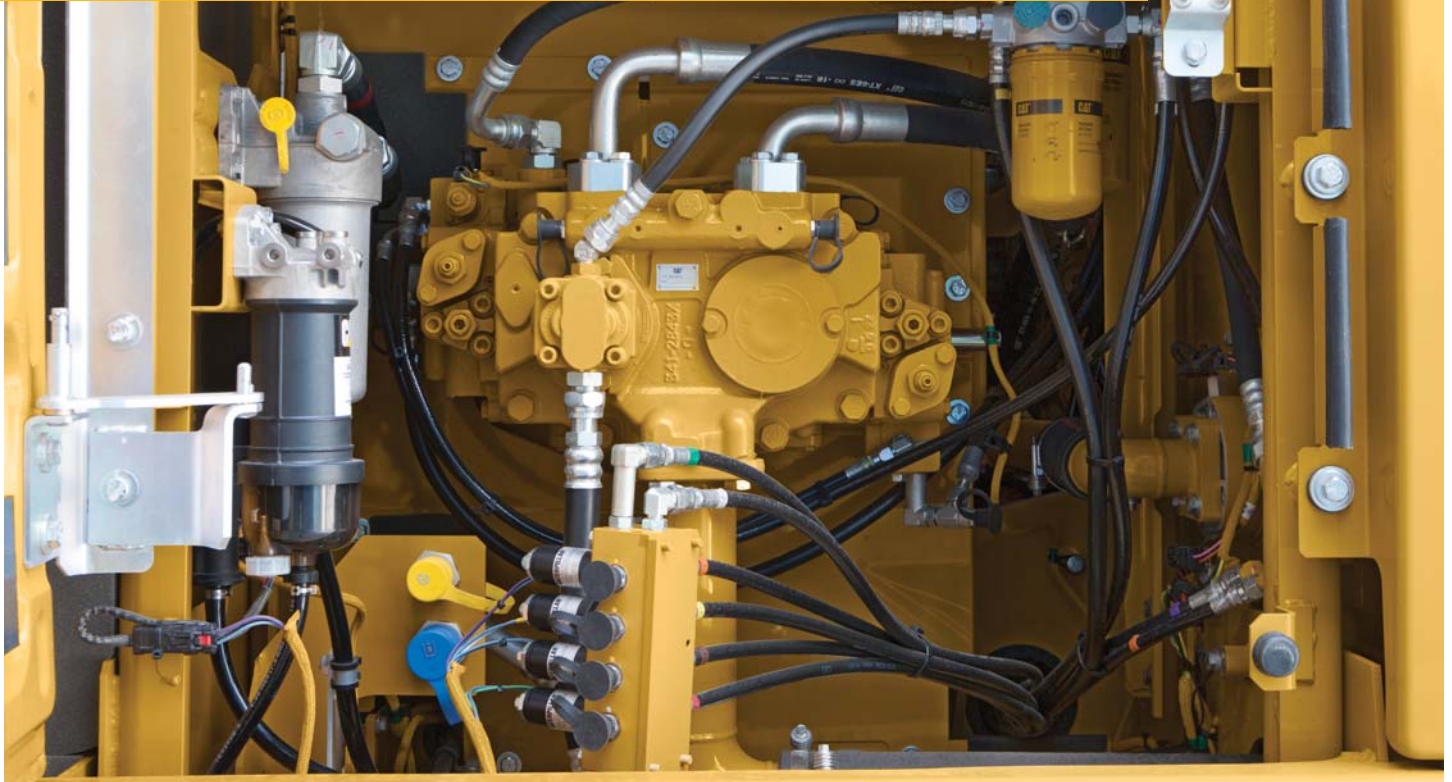

A Powerful, Efficient Design

When it comes to moving heavy material quickly and efficiently, you need hydraulic horsepower – the type of ground-breaking power the 323F L can deliver. Major hydraulic components like pumps and valves are located close together so shorter tubes and lines can be used. This design leads to less friction loss, reduced pressure drops, and more power to the ground for the work you need to get done.

Control Like No Other

Controllability is one of the main attributes of Cat excavators, and one of the key contributors to this is the main control valve. The valve opens slowly when your range of joystick lever movement is small and opens rapidly when movement is high. It puts flow where you need it when you need it, which leads to smoother operation, greater efficiency, and lower fuel consumption.

Auxiliary Hydraulics For Added Versatility

Auxiliary hydraulics give you greater tool versatility so you can take on more work with just one machine, and there are several options from which you can choose. A quick coupler circuit, for example, will allow you to switch from one tool to another in a matter of minutes – all from the comfort and convenience of the cab.

Boom & Stick Oil Re-Circulation For Added Efficiency

The 323F L regenerates the flow of oil from the head end of the boom and stick cylinders to the rod end of the boom and stick cylinders during the work cycle to save energy and improve fuel efficiency. It's optimized for any dial speed setting you select, which results in less pressure loss for higher controllability, more productivity, and lower operating costs for you.





Heavy Configuration

More brawn for your bigger jobs

More Lift

If your jobs require a lot of heavy lifting, look into the 323F L heavy counterweight configuration. This machine features nearly 5350 kg (11,794 lb) of weight out back – roughly 1250 kg (3,000 lb) more than our standard 323F L. It also has a reinforced frame to support the additional weight along with larger boom cylinders and heavy-duty undercarriage. The benefit to you is a well-designed, well-balanced machine that will lift up to 20 percent more weight out front and over the side than our standard model.

More Stability

With the heavy counterweight, you get a more stable platform for working with larger tools like a hydraulic thumb, multi-processor, and high-capacity buckets. It also helps keep the machine flat on its tracks when you are picking and placing large pipe and trench boxes, concrete construction barriers, and other heavy materials.



Operator Station

Comfort and convenience to keep you productive

A Safe, Quiet Cab

The ROPS cab provides you with a safe working environment. It also contributes to your comfort because it's attached to a reinforced frame with special viscous mounts that limit vibration and unnecessary sound. Add in special roof lining and sealing and you have a cab that's as quiet inside as today's top pickup trucks.

Comfortable Seat Options

The seat range includes air suspension, heated, and air cooled options. All seats include a reclining back, upper and lower slide adjustments, and height and tilt angle adjustments to meet your needs for maximum comfort.

A Cool & Warm Environment

The automatic climate control system features multiple air outlets with filtered ventilation. Air flows on the floor, behind the seat, and in front of you to make your work in either hot or cold weather much more pleasant and productive.

Controls Just For You

The right and left joystick consoles can be adjusted to improve your comfort and productivity during the course of a day. Also, the right joystick features a button that will reduce engine speed when you are not working to help save fuel. Touch it once and speed reduces; touch it again and speed increases for normal operation.

A Helpful Monitor

The LCD monitor is easy to see and navigate. Programmable in up to 42 languages to meet today's diverse workforce, the monitor clearly displays critical information you need to operate efficiently and effectively. Plus it projects the image from the standard rearview camera to help you see what's going on around you so you can stay safely focused on the job at hand.

Ample Storage & Auxiliary Power

Storage spaces are located in the front, rear, and side consoles of the cab. A drink holder accommodates a large mug, and a shelf behind the seat stores large lunch or toolboxes. Two 12-volt power supply sockets are conveniently located near the key storage areas for charging your electronic devices like an MP3 player, a cell phone, or a tablet.





Front Linkage

Options to take on your far-reaching and up-close tasks

Booms & Sticks

The 323F is offered with a range of booms and sticks. Each is built with internal baffle plates for added durability, and each undergoes ultrasound inspection to ensure weld quality and reliability. Large box-section structures with thick, multi-plate fabrications, castings, and forgings are used in high-stress areas such as the boom nose, boom foot, boom cylinder, and stick foot to improve durability. The boom nose pin is a captured flag design for enhanced durability.

Three Types Available

There are three basic boom types available to meet your work needs: Standard Reach, HD and SLR.

R = Reach

The standard Reach boom R5.7 m (18'8") is best used for reach applications where conditions are optimal such as excavating basements, trenching for utility lines, and working in sewer applications.

HD = Heavy Duty

This type of boom is best for the majority of your applications like up-close excavating, heavy-duty lifting, and breaking and demolishing a variety of material.

SLR = Super Long Reach

With reaches up to 15 720 mm (51'7"), this configuration is ideal for forming slopes and cleaning settlement tanks and ponds.

Sticks are matched to the boom you choose. Longer sticks are better when you need to dig deep or load trucks. Shorter sticks provide greater breakout force and increase your productivity when using hydromechanical work tools.

Talk to your Cat dealer to pick the best front linkage for your specific line of work.

Structures & Undercarriage

Designed to work in your rugged applications



Robust Frame

The 323F L is a well-built machine designed to give you a very long service life. The upper frame has mountings made specifically to support the heavy-duty cab; it is also reinforced around key areas that take on stress like the boom foot and skirt. Massive bolts are used to attach the track frames to the body, and additional bolts are used to increase the machine's digging force, which leads to more productivity for you.

Durable Undercarriage

The 323F L undercarriage contributes significantly to its outstanding stability and durability. Track shoes, links, rollers, idlers, and final drives are all built with long-lasting, high-tensile-strength steel. Cat Grease Lubricated Track 2 (GLT2) track link protects moving parts by keeping water, debris, and dust out and grease sealed in, which delivers longer wear life and reduced noise when traveling on either a flat, heavy bed of rock or a steep, wet field of mud.

Counterweight Options

Depending on the configuration you choose, three counterweight options – 4.1 mt (9,039 lb), 4.7 mt (10,360 lb), and 5.35 mt (11,794 lb) – are available. All are built with thick steel plates and reinforced fabrications to make them less susceptible to damage, and all have curved surfaces that match the machine's sleek, smooth appearance along with integrated housings to help protect the standard rearview camera.



Attachments

Tools to make you productive and profitable



Get The Most Out Of One Machine

You can easily expand the performance of your machine by utilizing any of the variety of attachments offered by Cat Work Tools.

Change Jobs Quickly & Accurately

Quick couplers like the Cat Pin Grabber allow you to switch tools for the job at hand with incredible ease and speed, helping to maximize your uptime. Caterpillar's optional tool control system takes it a step further by adding best-in-class accuracy because it can store the flows and pressures of up to 10 different work tools. Simply select the tool you need through the monitor and go to work – quickly and efficiently.

Dig, Finish, Load & Compact

A wide range of buckets dig everything from top soil to harsh, abrasive material. For finishing and grading work, compact and shallow ditch cleaning buckets fit the need. A Cat compactor prepares the area for the next phase of construction.

Break, Demolish & Scrap

A hydraulic hammer equips your machine for breaking rock in quarries and preparing trenches on construction sites. Taking down bridge pillars and heavily reinforced concrete is no problem. Multi-processor, pulverizer, and shear attachments take your machine into structure demolition jobs and process the debris for reuse and recycle.

Move & Handle

Add a thumb and you have the ability to move and handle brush, rocks, and debris. For constant material handling, a grapple is your solution. Choose from three different styles for picking, sorting, and loading trash, demolition debris, or recyclables.

Set Up Your Machine For Profitability

Your Cat dealer can install hydraulic kits to properly operate all Cat Work Tool attachments – maximizing the machine's uptime and your profits. All Cat Work Tool attachments are supported by the same Cat dealer network as your Cat machine.

GRAB, SORT, LOAD



Pro Series Hydraulic Thumbs



Stiff Link Thumbs



Contractors' Grapples



Trash Grapples

SWAP TOOLS



Pin Grabber Coupler

DIG & PACK



Ditch Cleaning and Tilt Buckets



General Duty Buckets



Heavy Duty Buckets



Severe Duty Buckets



Vibratory Plate Compactors

CUT, CRUSH, BREAK & RIP



Multi-Processors



Scrap & Demolition Shears



Secondary Pulverizers



Hydraulic Hammers



Rippers

Serviceability

Designed to make your maintenance quick and easy

Safe, Convenient Access

You can reach most routine maintenance items like fluid taps and grease points from the safety and convenience of ground level. You will also find filters banked together for higher service efficiency. Compartments feature wide service doors designed to help prevent debris entry, and they also securely latch in place to help make your service work simpler.

A Cool Design

The high-ambient cooling system features a fuel-saving variable-speed fan and a side-by-side-mounted radiator and oil and air coolers for easy cleaning. Wider clearance between the two makes blowing off debris easy for you, which can help improve your machine's reliability and performance.

A Fresh Idea

When you select ventilation inside the cab, outside air enters through the fresh air filter. The filter is conveniently located on the side of the cab to make it easy to reach and replace, and it is protected by a lockable door that can be opened with the engine key.

More Service Benefits

Filters are banked together to enhance service efficiency. The fuel tank's drain cock makes it easy and simple for you to remove water and sediment during routine maintenance. Plus an integrated fuel level indicator pops up to help you reduce the possibility of fuel tank overfilling.

Smart Refuel

Smart refuel is an on-board pump system that lets you fill the machine quickly from an external source like a fuel drum. What's smart about it is that it automatically stops when the fuel tank is full or the fuel source is empty, eliminating guess work and premature pump wear.

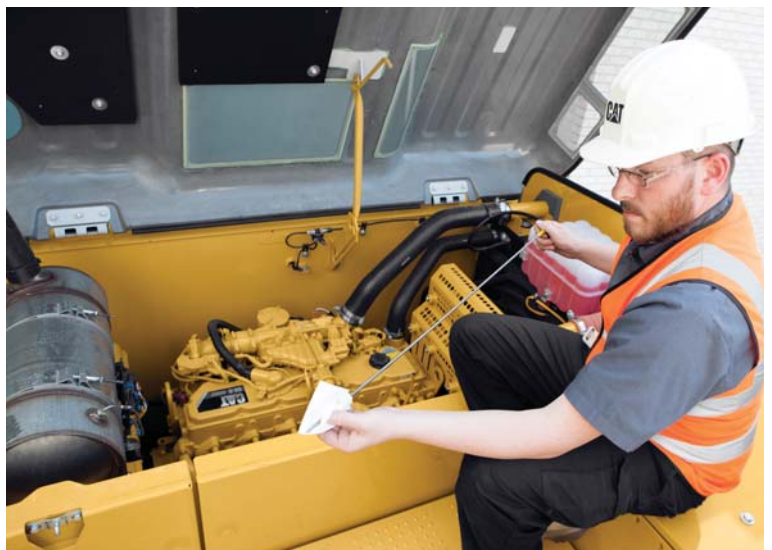
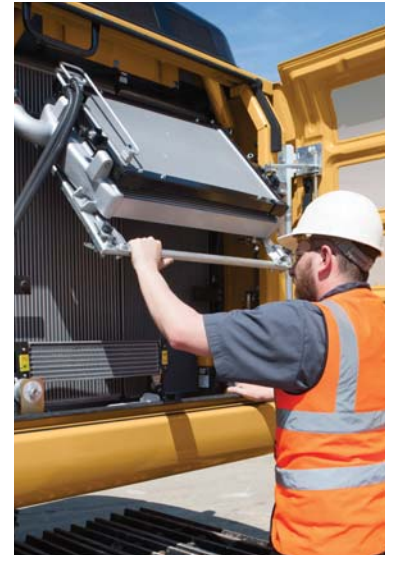

Safety

Features to help protect you day in and day out



A Safe, Quiet Cab

The ROPS cab provides you with a safe working environment when properly seated and belted. It also contributes to your comfort because it's attached to a reinforced frame with special viscous mounts that limit vibration and unnecessary sound. Add in special roof lining and sealing and you have a cab that's as quiet inside as any of today's top pickup trucks.

Secure Contact Points

Multiple large steps get you into the cab as well as a leg up to the compartments. Extended hand and guard rails allow you to safely climb to the upper deck. Anti-skid plates reduce your slipping hazards in all types of weather conditions, and they can be removed for cleaning.

Great Views

Ample glass gives you excellent visibility out front and to the side, and the standard rearview camera gives you a clear field of view behind the machine through the cab monitor. The available split-configuration windshield features an upper window with handles that make it easy to slide and store above you and a lower window that can be removed and stored on the inside wall of the cab. The large skylight also serves as an emergency exit and provides you with enhanced overhead visibility.

Smart Lighting

Halogen lights provide plenty of illumination, and the cab and boom lights can be programmed to stay on for up to 90 seconds after the engine has been turned off to help you safely exit the machine.

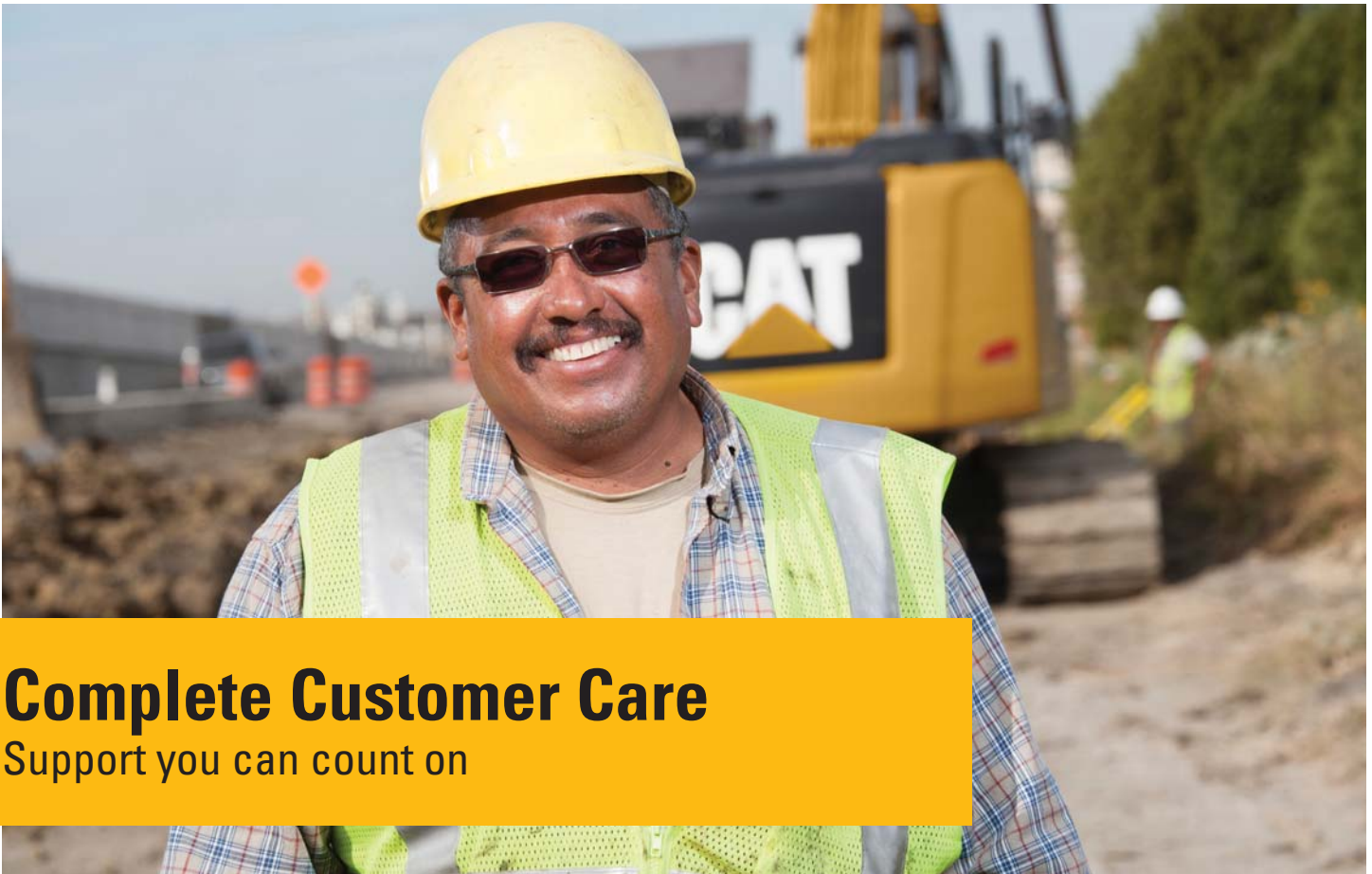

Complete Customer Care

Support you can count on

Worldwide Parts Availability

Cat dealers utilize a worldwide parts network to maximize your machines' uptime. Plus they can help you save money with Cat remanufactured components.

Advice You Can Trust

What are the job requirements and machine attachments? What production is needed? Your Cat dealer can provide recommendations to help you make the right machine choices.

Financial Options Just For You

Consider financing options and day-to-day operating costs. Look at dealer services that can be included in the machine's cost to yield lower owning and operating costs over time.

Support Agreements To Fit Your Needs

Cat dealers offer a variety of customer support agreements and work with you to develop a plan to meet your specific needs. These plans can cover the entire machine, including attachments, to help protect your investment.

Operating Techniques To Boost Your Profits

Improving operating techniques can boost your profits. Your Cat dealer has videos, literature, and other ideas to help you increase productivity. Caterpillar also offers simulators and certified operator training to help maximize the return on your investment.

What's Best For You Today... And Tomorrow

Repair, rebuild, or replace? Your Cat dealer can help you evaluate the cost involved so you can make the best choice for your business.

Sustainability

Generations ahead in every way

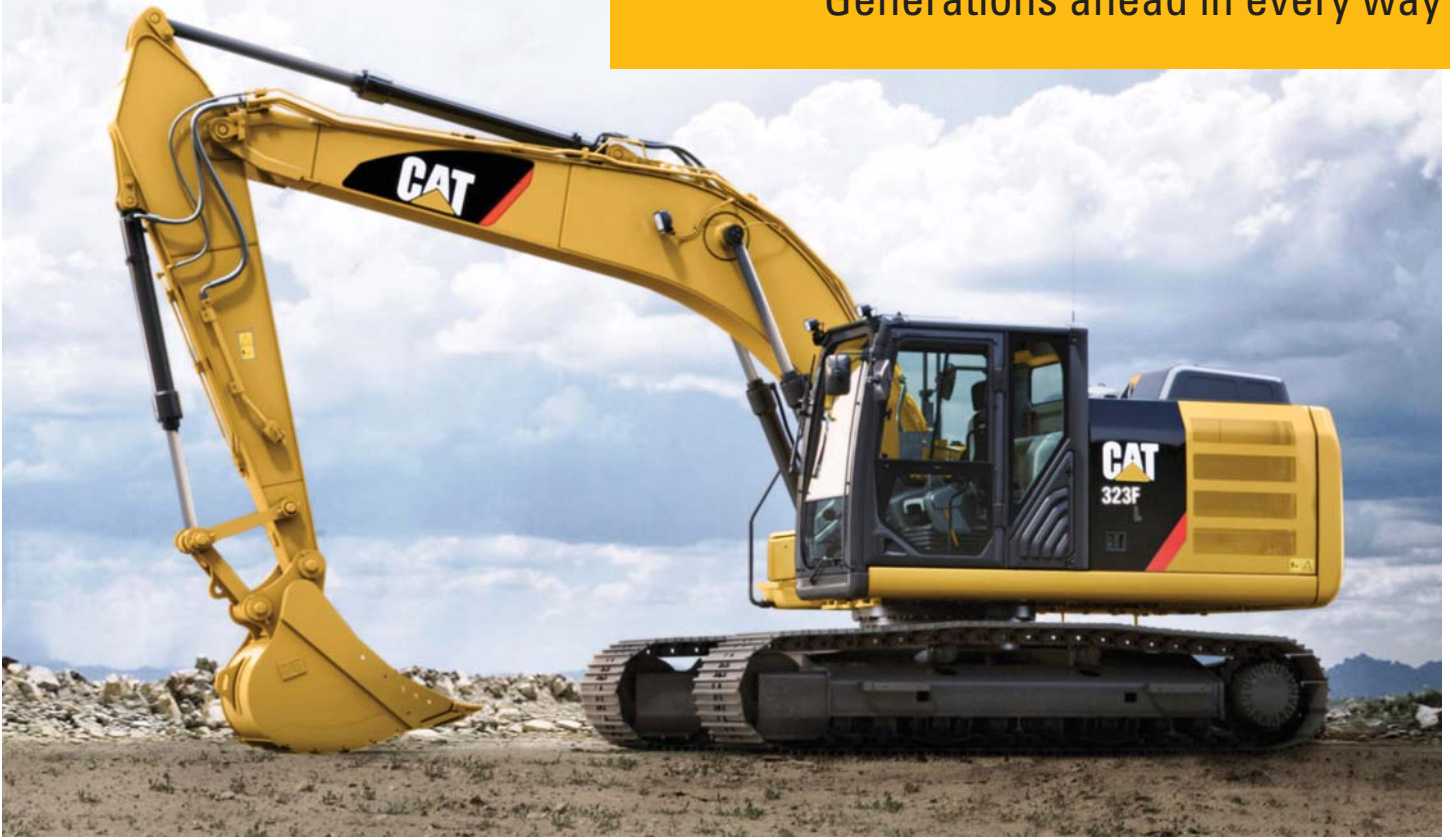

- The C7.1 ACERT engine meets Tier 4 Final/Stage IV emission standards.
- The 323F L burns less fuel than the 320E model it replaces, which means less emissions.
- Cat Grade Control Depth and Slope is standard with the R2.9 (9'6") stick and R2.5 (8'2") stick, improving job site efficiency.
- The machine has the flexibility of running on either ultra-low-sulfur diesel (ULSD) fuel with 15 ppm of sulfur or less or biodiesel (up to B20) fuel blended with ULSD.
- A ground-level overfill indicator rises when the tank is full to help the operator avoid spilling.
- The QuickEvac™ option ensures fast, easy, and secure changing of engine and hydraulic oil.
- The machine is built to be rebuilt with major structures and components capable of being remanufactured to reduce waste and replacement costs.
- Overall, the 323F L is an efficient, productive machine that's designed to conserve our natural resources for generations ahead.

323F L Hydraulic Excavator Specifications

Engine

Engine Model	Cat C7.1 ACERT	
Net Power – SAE J1349/ISO 9249	120 kW	161 hp
Gross Power – SAE J1995/ISO 14396	122 kW	164 hp
Engine rpm		
Operation	1,500 rpm	
Travel	1,800 rpm	
Bore	105 mm	4.1 in
Stroke	135 mm	5.3 in
Displacement	7.1 L	433 in ³

- The 323F L meets Tier 4 Final/Stage IV emission standards.
- No engine power derating required below 3000 m (9,840 ft) altitude.
- Net power advertised is the power available at the flywheel when the engine is equipped with fan, air cleaner, muffler and alternator.
- Power rating at 1,800 rpm (Implement).

Weights

Operating Weight (ANZ)*	25 000 kg	55,100 lb
Operating Weight (ADSD-N)**	23 100 kg	50,900 lb

*Long undercarriage, 5.35 mt (11,794 lb) counterweight, HD R5.7 (18'8") boom, R2.9 (9'6") stick, HD 1.19 m³ (1.56 yd³) bucket and 790 mm (31 in) HD shoes.

**Long undercarriage, 4.1 mt (9,039 lb) counterweight, R5.7 (18'8") boom, R2.9 (9'6") stick, HD 1.19 m³ (1.56 yd³) bucket and 790 mm (31 in) HD shoes.

Track

Standard with Long Undercarriage	790 mm	31 in
Optional for Long Undercarriage (ANZ only)	700 mm	28 in
Optional for Long Undercarriage	600 mm	24 in
Number of Shoes Each Side – Long Undercarriage	49	
Number of Track Rollers Each Side – Long Undercarriage	8	
Number of Carrier Rollers Each Side	2	

Swing Mechanism

Swing Speed	11.0 rpm	
Maximum Swing Torque	74 kN·m	54,440 lbf·ft

Drive

Maximum Gradeability	35°/70%	
Maximum Travel Speed	5.5 km/h	3.4 mph
Maximum Drawbar Pull	205 kN	46,090 lbf

Hydraulic System

Main System		
Maximum Flow (2 pumps)	423 L/min	112 gal/min
Maximum Flow (per pump)	212 L/min	56 gal/min
Maximum Pressure – Equipment – Heavy Lift Mode	38 000 kPa	5,511 psi
Maximum Pressure – Equipment/Travel	35 000 kPa	5,076 psi
Maximum Pressure – Swing	25 500 kPa	3,698 psi
Pilot System Maximum Flow for Implement	20 L/min	5.3 gal/min
Pilot System Maximum Pressure	3920 kPa	569 psi
Boom Cylinder – Bore	120 mm	4.7 in
Boom Cylinder – Stroke	1260 mm	49.6 in
Stick Cylinder – Bore	140 mm	5.5 in
Stick Cylinder – Stroke	1504 mm	59.2 in
Bucket Cylinder – Bore	120 mm	4.7 in
Bucket Cylinder – Stroke	1104 mm	43.5 in

Service Refill Capacities

Fuel Tank Capacity	410 L	108.3 gal
Cooling System	30 L	7.9 gal
Engine Oil	25 L	6.6 gal
Swing Drive (each)	8 L	2.1 gal
Final Drive (each)	8 L	2.1 gal
Hydraulic System (including tank)	260 L	68.7 gal
Hydraulic Tank	159 L	42.0 gal
DEF Tank	20 L	5.3 gal

Sound Performance

ISO 6395 (External)	100 dB(A)
ISO 6396 (Inside Cab)	68 dB(A)

- When properly installed and maintained, the cab offered by Caterpillar, when tested with doors and windows closed according to ANSI/SAE J1166 OCT98, meets the requirements for operator sound exposure limits in effect at time of manufacture.
- Hearing protection may be needed when operating with an open operator station and cab (when not properly maintained or doors/windows open) for extended periods or in a noisy environment.

Standards

Brakes	ISO 10265 2008
Cab/FOGS	ISO 10262 1998
Cab/ROPS	ISO 12117-2 2008

323F L Hydraulic Excavator Specifications

Dimensions

All dimensions are approximate.

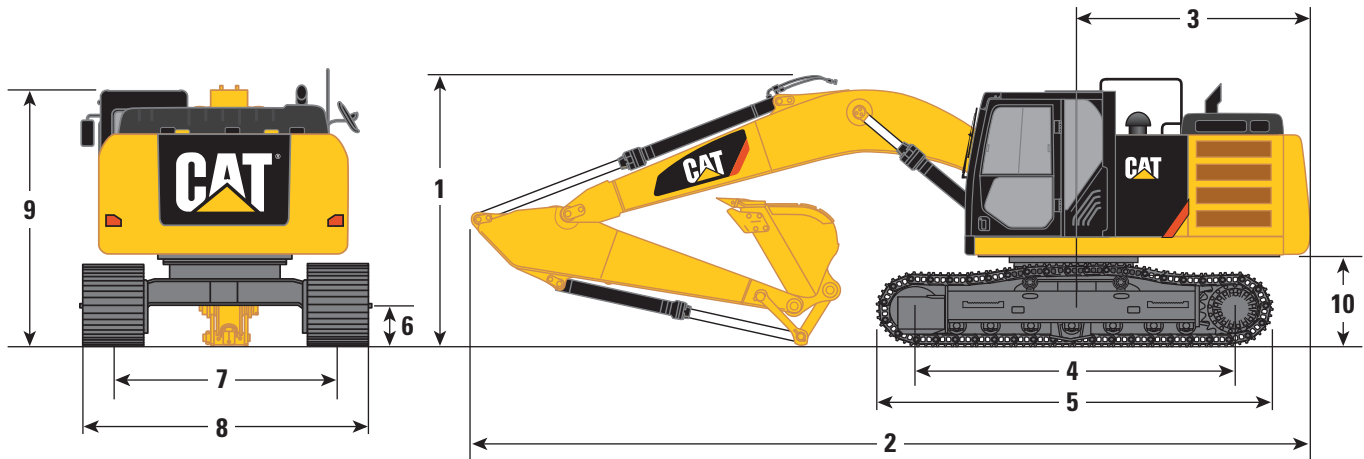

Regions	ADSD-N		ADSD-N/ANZ		ANZ		ADSD-N/ANZ	
Boom Options	Reach Boom and HD Reach Boom 5.7 m (18'8")						Super Long Reach 8.85 m (29'0")	
Stick Options	R3.9 (12'10")**		R2.9 (9'6")*		R2.5 (8'2")**		SLR 6.28 (20'7")***	
1 Shipping Height	3450 mm	11'4"	3130 mm	10'3"	3050 mm	10'0"	3210 mm	10'6"
2 Shipping Length	9340 mm	30'8"	9540 mm	31'4"	9450 mm	31'0"	12 750 mm	41'10"
3 Tail Swing Radius	2830 mm	9'3"	2830 mm	9'3"	2830 mm	9'3"	2830 mm	9'3"
4 Length to Center of Rollers – Long Undercarriage	3650 mm	12'0"	3650 mm	12'0"	3650 mm	12'0"	3650 mm	12'0"
5 Track Length – Long Undercarriage	4460 mm	14'8"	4460 mm	14'8"	4460 mm	14'8"	4460 mm	14'8"
6 Ground Clearance	450 mm	1'6"	450 mm	1'6"	450 mm	1'6"	450 mm	1'6"
7 Track Gauge – Long Undercarriage (shipping)	2380 mm	7'10"	2380 mm	7'10"	2380 mm	7'10"	2380 mm	7'10"
8 Transport Width – Long Undercarriage								
600 mm (24 in) Shoes	2980 mm	9'9"	2980 mm	9'9"	2980 mm	9'9"	2980 mm	9'9"
700 mm (28 in) Shoes (ANZ only)	—	—	3080 mm	10'1"	3080 mm	10'1"	3080 mm	10'1"
790 mm (31 in) Shoes	3170 mm	10'5"	3170 mm	10'5"	3170 mm	10'5"	3170 mm	10'5"
9 Handrail Height	3010 mm	9'11"	3010 mm	9'11"	3010 mm	9'11"	3010 mm	9'11"
10 Counterweight Clearance	1020 mm	3'4"	1020 mm	3'4"	1020 mm	3'4"	1020 mm	3'4"

*With 1.19 m³ (1.56 yd³) bucket and 790 mm (31 in) shoes.

**With 1.3 m³ (1.70 yd³) bucket and 600 mm (24 in) shoes and North American only.

***With 0.53 m³ (0.69 yd³) bucket and 790 mm (31 in) shoes.

323F L Hydraulic Excavator Specifications

Working Ranges

All dimensions are approximate.

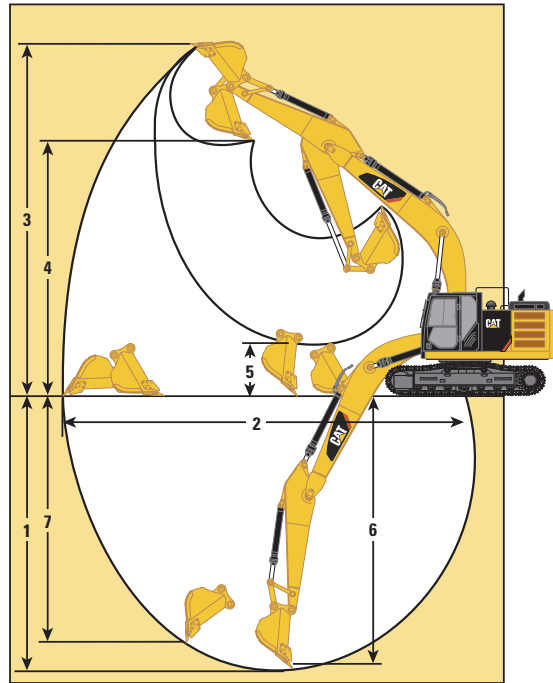

Regions	ADSD-N		ADSD-N/ANZ		ANZ	
Boom Options	Reach Boom and HD Reach Boom 5.7 m (18'8")					
Stick Options	R3.9 (12'10")		R2.9 (9'6")		R2.5 (8'2")	
Bucket Type and Capacity	HD 1.19 m ³ (0.91 yd ³)		HD 1.19 m ³ (0.91 yd ³)		GD 1.3 m ³ (1.7 yd ³)	
1 Maximum Digging Depth	7580 mm	24'10"	6720 mm	22'1"	6290 mm	20'8"
2 Maximum Reach at Ground Line	10 680 mm	35'0"	9860 mm	32'4"	9450 mm	31'0"
3 Maximum Cutting Height	9870 mm	32'5"	9370 mm	30'9"	9240 mm	30'3"
4 Maximum Loading Height	7030 mm	23'1"	6490 mm	21'4"	6300 mm	20'8"
5 Minimum Loading Height	1310 mm	4'4"	2170 mm	7'1"	2600 mm	8'6"
6 Maximum Depth Cut for 2440 mm (8 ft) Level Bottom	7440 mm	24'5"	6550 mm	21'6"	6100 mm	20'0"
7 Maximum Vertical Wall Digging Depth	6910 mm	22'8"	5060 mm	16'7"	5210 mm	17'1"
Bucket Digging Force (SAE)	132 kN	29 630 lbf	134 kN	30,102 lbf	126 kN	28,281 lbf
Bucket Digging Force (ISO)	148 kN	33 249 lbf	150 kN	33,811 lbf	140 kN	31,563 lbf
Stick Digging Force (SAE)	88 kN	19 873 lbf	103 kN	23,223 lbf	115 kN	25,786 lbf
Stick Digging Force (ISO)	91 kN	20 368 lbf	106 kN	23,920 lbf	118 kN	26,572 lbf

323F L Hydraulic Excavator Specifications

Working Ranges

All dimensions are approximate.

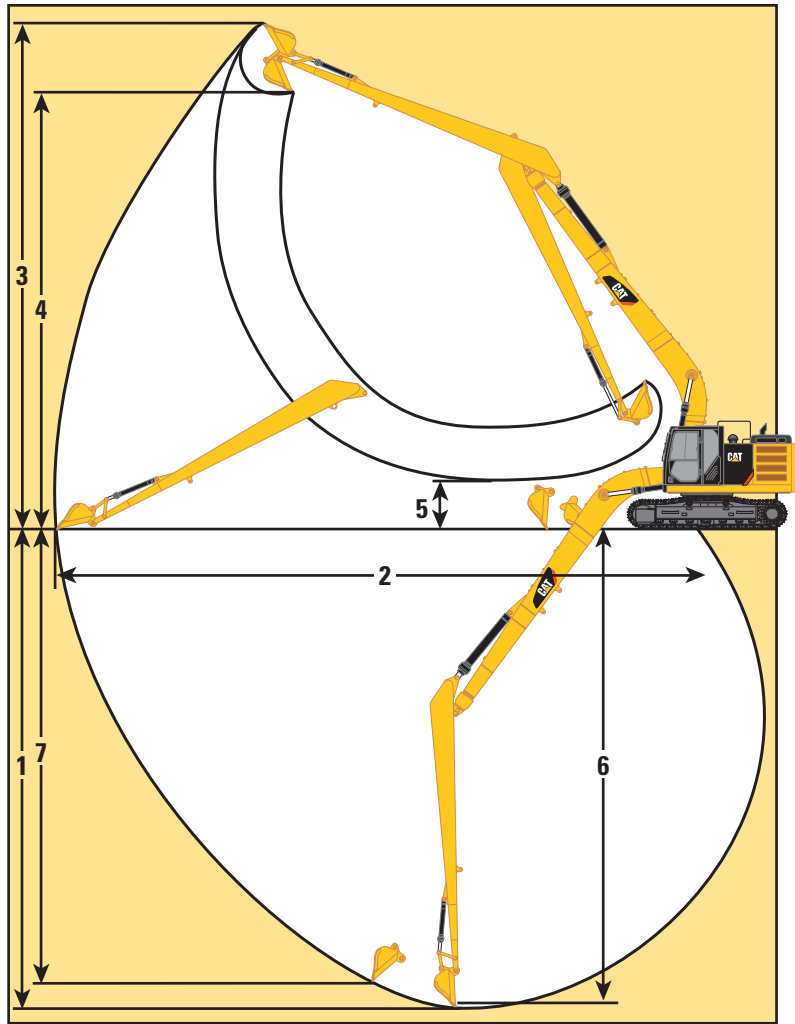

Regions	ADSD-N/ANZ	
Boom Option	Super Long Reach Boom 8.85 m (29'0")	
Stick Option	SLR 6.28 m (20'7")	
Bucket Type and Capacity	General Purpose 0.53 m ³ (0.69 yd ³)	
1 Maximum Digging Depth	11 690 mm	38'4"
2 Maximum Reach at Ground Line	15 720 mm	51'7"
3 Maximum Cutting Height	13 590 mm	44'7"
4 Maximum Loading Height	11 290 mm	37'0"
5 Minimum Loading Height	2090 mm	6'10"
6 Maximum Depth Cut for 2440 mm (8 ft) Level Bottom	11 280 mm	37'0"
7 Maximum Vertical Wall Digging Depth	10 670 mm	35'0"
Bucket Digging Force (SAE)	54 kN	12,185 lbf
Bucket Digging Force (ISO)	61 kN	13,691 lbf
Stick Digging Force (SAE)	48 kN	10,813 lbf
Stick Digging Force (ISO)	49 kN	10,948 lbf

323F L Hydraulic Excavator Specifications

Operating Weight and Ground Pressure

Regions	ADSD-N		ADSD-N		ANZ		ANZ		ADSD-N	
	790 mm (31 in) TG Shoes (HD)		790 mm (31 in) TG Shoes		700 mm (28 in) TG Shoes (HD)		600 mm (24 in) TG Shoes (HD)		600 mm (24 in) SG Shoes	
	kg (lb)	kPa (psi)	kg (lb)	kPa (psi)	kg (lb)	kPa (psi)	kg (lb)	kPa (psi)	kg (lb)	kPa (psi)
Long Undercarriage										
4.1 mt (9,039 lb) Counterweight, R5.7 (18'8") Boom										
R2.9 (9'6") Stick, HD 1.19 m ³ (1.56 yd ³) Bucket										
			23 100 (50,900)	36.5 (5.29)					22 800 (50,300)	47.4 (6.88)
5.35 mt (11,794 lb) Counterweight, HD R5.7 (18'8") Boom										
R2.9 (9'6") Stick, HD 1.19 m ³ (1.56 yd ³) Bucket										
			25 000 (55,100)	39.5 (5.73)	24 800 (54,700)	44.2 (6.41)	24 300 (53,600)	50.5 (7.33)		
R2.5 (8'2") Stick, HD 1.19 m ³ (1.56 yd ³) Bucket										
			25 000 (55,100)	39.5 (5.73)	24 700 (54,500)	44.0 (6.39)	24 300 (53,600)	50.5 (7.33)		
4.7 mt (10,360 lb) Counterweight, SLR Boom										
SLR Stick, Ditch-Cleaning 0.57 m ³ (0.75 yd ³) Bucket										
			24 600 (54,200)	38.9 (5.64)	24 300 (53,600)	43.3 (6.28)	23 900 (52,700)	49.7 (7.21)		
SLR Stick, Ditch-Cleaning 0.53 m ³ (0.69 yd ³) Bucket										
			24 100 (53,100)	38.1 (5.52)						

Major Component Weights

	kg	lb
Upper Structure with 4.1 mt (9,039 lb) Counterweight	11 190	24,670
Upper Structure with 4.7 mt (10,360 lb) Counterweight for SLR	11 790	25,990
Upper Structure with 5.35 mt (11,794 lb) Counterweight	12 650	27,890
Lower Structure with 790 mm (31") Triple Grouser HD Shoes	8320	18,340
Lower Structure with 790 mm (31") Triple Grouser Shoes	7880	17,370
Lower Structure with 700 mm (28") Triple Grouser HD Shoes	8030	17,700
Lower Structure with 600 mm (24") Triple Grouser HD Shoes	7620	16,800
Lower Structure with 600 mm (24") Single Grouser Shoes	7620	16,800
Reach Boom (includes lines, pins, two boom cylinders, stick cylinder)	2010	4,430
Reach Boom, Heavy Lift Configuration (includes lines, pins, two boom cylinders, stick cylinder)	2100	4,630
Super Long Reach Boom (includes lines, pins, two boom cylinders, stick cylinder)	2740	6,040
R3.9 (12'10") Stick (includes lines, pins, bucket cylinder and linkage)	1230	2,710
R2.9 (9'6") Stick (includes lines, pins, bucket cylinder and linkage)	980	2,160
R2.9 (9'6") Thumb Stick (includes lines, pins, bucket cylinder and linkage)	1260	2,780
R2.5 (8'2") Stick (includes lines, pins, bucket cylinder and linkage)	960	2,120
Super Long Reach Stick (includes lines, pins, bucket cylinder and linkage)	1330	2,930
GD 0.81 m ³ (1.06 yd ³) Bucket	700	1,540
HD 1.19 m ³ (1.56 yd ³) Bucket (ADSD-N only)	1020	2,250
GD 1.3 m ³ (1.69 yd ³) Bucket	880	1,940
HD 1.19 m ³ (1.56 yd ³) Bucket (ANZ only)	980	2,160
GD 0.57 m ³ (0.75 yd ³) Bucket	400	880
Ditch-Cleaning 0.57 m ³ (0.75 yd ³) Bucket	330	730

323F L Hydraulic Excavator Specifications

Reach Boom Lift Capacities – Heavy Counterweight: 5.35 mt (11,794 lb) – without Bucket – Heavy Lift On

Region: ADSD-N

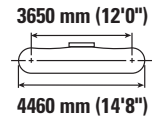
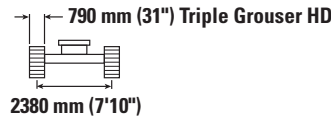
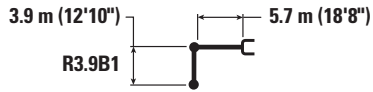

		1500 mm/60 in		3000 mm/120 in		4500 mm/180 in		6000 mm/240 in		7500 mm/300 in		9000 mm/360 in		mm in		
7500 mm 300 in	kg lb													*3000 *6,600	*3000 *6,600	7320 290
6000 mm 240 in	kg lb									*4600 *9,600	*4600 *9,600			*2800 *6,150	*2800 *6,150	8300 330
4500 mm 180 in	kg lb									*5300 *11,650	4750 10,150			*2750 *6,050	*2750 *6,050	8920 350
3000 mm 120 in	kg lb					*7900 *17,000	*7900 *17,000	*6550 *14,200	6400 13,700	*5850 *12,750	4600 9,850	*3850 *7,150	3500 *7,150	*2800 *6,150	*2800 *6,150	9250 370
1500 mm 60 in	kg lb			*9800 *23,300	*9800 *23,300	*10 250 *22,050	9150 19,700	*7750 *16,750	6100 13,100	*6500 *14,100	4450 9,550	*4450 *8,500	3400 7,300	*2950 *6,450	*2950 *6,450	9330 370
0 mm 0 in	kg lb			*8050 *18,450	*8050 *18,450	*11 950 *25,800	8700 18,750	*8700 *18,900	5850 12,600	6600 14,200	4300 9,250	*4150 *7,250	3350 7,200	*3200 *7,050	*3200 *7,050	9160 360
-1500 mm -60 in	kg lb	*6050 *13,500	*6050 *13,500	*10 400 *23,550	*10 400 *23,550	*12 700 *27,450	8500 18,300	9000 19,350	5700 12,300	6500 14,050	4250 9,100			*3650 *8,000	3450 7,650	8730 350
-3000 mm -120 in	kg lb	*9400 *21,050	*9400 *21,050	*14 400 *32,750	*14 400 *32,750	*12 500 *27,050	8500 18,250	8950 19,300	5650 12,200	6500 14,050	4200 9,100			*4450 *9,850	3900 8,600	8000 320
-4500 mm -180 in	kg lb	*13 650 *30,750	*13 650 *30,750	*16 250 *34,950	*16 250 *34,950	*11 300 *24,250	8600 18,500	*8300 *17,650	5750 12,400					*6150 *13,850	4850 10,800	6870 270
-6000 mm -240 in	kg lb					*8050 *8050	*8050 *8050							*7100 *7100	*7100 *7100	4910



ISO 10567



*Indicates that the load is limited by hydraulic lifting capacity rather than tipping load. The above loads are in compliance with hydraulic excavator lift capacity standard ISO 10567:2007. They do not exceed 87% of hydraulic lifting capacity or 75% of tipping load. Weight of all lifting accessories must be deducted from the above lifting capacities. Lifting capacities are based on the machine standing on a firm, uniform supporting surface. The use of a work tool attachment point to handle/lift objects, could affect the machine lift performance.

Lift capacity stays with ±5% for all available track shoes.

Always refer to the appropriate Operation and Maintenance Manual for specific product information.

323F L Hydraulic Excavator Specifications

Reach Boom Lift Capacities – Heavy Counterweight: 5.35 mt (11,794 lb) – without Bucket – Heavy Lift On

Region: ADSD-N

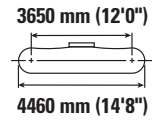
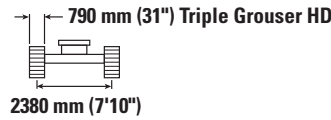
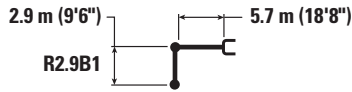

Reach (mm/in)	Unit	1500 mm/60 in		3000 mm/120 in		4500 mm/180 in		6000 mm/240 in		7500 mm/300 in		mm/in		
		Hydraulic	Tipping	Hydraulic	Tipping	Hydraulic	Tipping	Hydraulic	Tipping	Hydraulic	Tipping	Hydraulic	Tipping	
7500 mm 300 in	kg lb							*4950	*4950			*4300 *9,500	*4300 *9,500	6150 240
6000 mm 240 in	kg lb							*6000 *13,150	*6000 *13,150			*3950 *8,750	*3950 *8,750	7290 290
4500 mm 180 in	kg lb							*6600 *14,350	6550 14,150	*6200 *12,450	4700 10,150	*3900 *8,550	*3900 *8,550	7990 320
3000 mm 120 in	kg lb					*9650 *20,750	9550 20,600	*7600 *16,450	6350 13,650	*6650 *14,450	4600 9,950	*4000 *8,750	3950 8,700	8360 330
1500 mm 60 in	kg lb					*11 700 *25,200	9100 19,550	*8600 *18,650	6100 13,150	6800 14,650	4500 9,700	*4200 *9,250	3850 8,400	8450 340
0 mm 0 in	kg lb			*6600 *15,150	*6600 *15,150	*12 800 *27,700	8800 18,950	9250 19,900	5950 12,800	6700 14,450	4400 9,500	*4650 *10,250	3900 8,550	8260 330
-1500 mm -60 in	kg lb	*7050 *15,750	*7050 *15,750	*11 400 *25,850	*11 400 *25,850	*12 950 *28,000	8700 18,750	9150 19,700	5850 12,650	6700 14,400	4400 9,450	*5500 *12,100	4200 9,250	7780 310
-3000 mm -120 in	kg lb	*12 100 *27,100	*12 100 *27,100	*17 150 *37,150	16 800 36,000	*12 100 *26,200	8750 18,850	*9000 *19,400	5900 12,700			*7100 *15,800	4900 10,850	6950 280
-4500 mm -180 in	kg lb			*13 700 *29,400	*13 700 *29,400	*9900 *21,050	8950 19,300					*7500 *16,450	6650 14,950	5600 220

Reach Boom Lift Capacities – Heavy Counterweight: 5.35 mt (11,794 lb) – without Bucket – Heavy Lift On

Region: ADSD-N

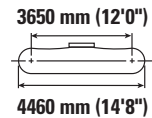
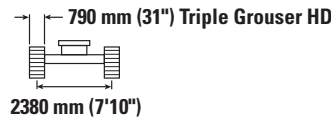
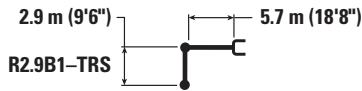

Reach (mm/in)	Unit	1500 mm/60 in		3000 mm/120 in		4500 mm/180 in		6000 mm/240 in		7500 mm/300 in		mm/in		
		Hydraulic	Tipping	Hydraulic	Tipping	Hydraulic	Tipping	Hydraulic	Tipping	Hydraulic	Tipping	Hydraulic	Tipping	
7500 mm 300 in	kg lb							*4900	*4900			*4200 *9,350	*4200 *9,350	6150 240
6000 mm 240 in	kg lb							*5850 *12,800	*5850 *12,800			*3900 *8,600	*3900 *8,600	7290 290
4500 mm 180 in	kg lb							*6400 *13,950	*6400 13,850	*6050 *12,300	4550 9,800	*3850 *8,400	*3850 *8,400	7990 320
3000 mm 120 in	kg lb					*9400 *20,200	9350 20,200	*7400 *16,000	6150 13,300	*6450 *14,050	4450 9,600	*3900 *8,600	3800 8,350	8360 330
1500 mm 60 in	kg lb					*11 400 *24,550	8800 19,000	*8400 *18,150	5900 12,750	6650 14,300	4350 9,350	*4150 *9,100	3650 8,050	8450 340
0 mm 0 in	kg lb			*6550 *15,000	*6550 *15,000	*12 500 *27,000	8500 18,350	9050 19,450	5750 12,350	6550 14,050	4250 9,150	*4600 *10,100	3750 8,200	8260 330
-1500 mm -60 in	kg lb	*7000 *15,600	*7000 *15,600	*11 350 *25,750	*11 350 *25,750	*12 600 *27,300	8450 18,150	8950 19,250	5650 12,150	6500 14,000	4200 9,100	*5400 *11,900	4050 8,850	7780 310
-3000 mm -120 in	kg lb	*12 000 *26,950	*12 000 *26,950	*16 750 *36,250	16 350 35,050	*11 800 *25,550	8500 18,300	*8750 *18,850	5700 12,250			*7000 *15,600	4700 10,450	6950 280
-4500 mm -180 in	kg lb			*13 350 *28,650	*13 350 *28,650	*9600 *20,450	8700 18,800					*7250 *15,950	6450 14,550	5600 220



ISO 10567



*Indicates that the load is limited by hydraulic lifting capacity rather than tipping load. The above loads are in compliance with hydraulic excavator lift capacity standard ISO 10567:2007. They do not exceed 87% of hydraulic lifting capacity or 75% of tipping load. Weight of all lifting accessories must be deducted from the above lifting capacities. Lifting capacities are based on the machine standing on a firm, uniform supporting surface. The use of a work tool attachment point to handle/lift objects, could affect the machine lift performance.

Lift capacity stays with ±5% for all available track shoes.

Always refer to the appropriate Operation and Maintenance Manual for specific product information.

323F L Hydraulic Excavator Specifications

Reach Boom Lift Capacities – Heavy Counterweight: 5.35 mt (11,794 lb) – without Bucket

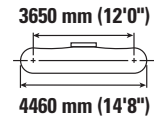
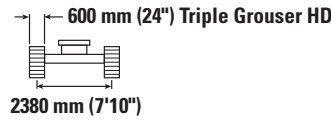
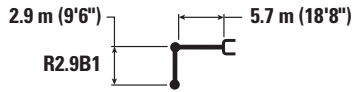

		1500 mm/60 in		3000 mm/120 in		4500 mm/180 in		6000 mm/240 in		7500 mm/300 in		mm in		
7500 mm 300 in	kg lb							*4550	*4550			*3900 *8,700	*3900 *8,700	6150 240
6000 mm 240 in	kg lb							*4900 *10,750	*4900 *10,750			*3650 *8,000	*3650 *8,000	7290 290
4500 mm 180 in	kg lb							*5400 *11,700	*5400 *11,700	*5050	4550	*3550 *7,850	*3550 *7,850	7990 320
3000 mm 120 in	kg lb					*7850 *16,900	*7850 *16,900	*6200 *13,400	6100 13,150	*5400 *11,750	4450	*3650 *8,000	*3650 *8,000	8360 330
1500 mm 60 in	kg lb					*9500 *20,500	8700 18,750	*7000 *15,150	5850 12,600	*5800 *12,600	4300 9,300	*3850 *8,500	3650 8,050	8450 340
0 mm 0 in	kg lb			*6250 *14,300	*6250 *14,300	*10 450 *22,550	8 450 18,150	*7600 *16,450	5700 12,250	*6100 *13,200	4250 9,100	*4250 *9,400	3750 8,200	8260 330
-1500 mm -60 in	kg lb	*6650 *14,850	*6650 *14,850	*10 750 *24,400	*10 750 *24,400	*10 550 *22,800	8350 17,950	*7800 *16,850	5600 12,100	*6050 *13,050	4200 9,050	*5000 *11,050	4000 8,850	7780 310
-3000 mm -120 in	kg lb	*11 400 *25,600	*11 400 *25,600	*13 950 *30,250	*13 950 *30,250	*9850 *21,300	8400 18,100	*7300 *15,750	5650 12,200			*6000 *13,200	4700 10,400	6950 280
-4500 mm -180 in	kg lb			*11 150 *23,850	*11 150 *23,850	*8000 *17,050	*8000 *17,050					*6050 *13,300	*6050 *13,300	5600 220

Reach Boom Lift Capacities – Heavy Counterweight: 5.35 mt (11,794 lb) – without Bucket – Heavy Lift On

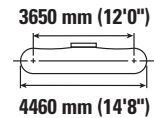
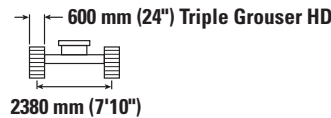
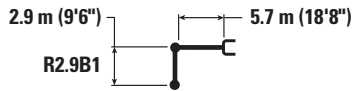

		1500 mm/60 in		3000 mm/120 in		4500 mm/180 in		6000 mm/240 in		7500 mm/300 in		mm in		
7500 mm 300 in	kg lb							*4950	*4950			*4300 *9,500	*4300 *9,500	6150 240
6000 mm 240 in	kg lb							*5400 *11,850	*5400 *11,850			*3950 *8,750	*3950 *8,750	7290 290
4500 mm 180 in	kg lb							*5950 *12,900	*5950 *12,900	*5600	4550	*3900 *8,550	*3900 *8,550	7990 320
3000 mm 120 in	kg lb					*8650 *18,650	*8650 *18,650	*6800 *14,750	6100 13,150	*5950 *13,000	4450	*4000 *8,750	3800 8,300	8360 330
1500 mm 60 in	kg lb					*10 500 *22,650	8700 18,750	*7750 *16,750	5850 12,600	*6400 *13,900	4300 9,300	*4200 *9,250	3650 8,050	8450 340
0 mm 0 in	kg lb			*6600 *15,150	*6600 *15,150	*11 500 *24,900	8450 18,150	*8400 *18,200	5700 12,250	6450 13,850	4250 9,100	*4650 *10,250	3750 8,200	8260 330
-1500 mm -60 in	kg lb	*7050 *15,750	*7050 *15,750	*11 400 *25,850	*11 400 *25,850	*11 650 *25,200	8350 17,950	*8600 *18,600	5600 12,100	6400 13,800	4200 9,050	*5500 *12,100	4000 8,850	7780 310
-3000 mm -120 in	kg lb	*12 100 *27,100	*12 100 *27,100	*15 450 *33,400	*15 450 *33,400	*10 900 *23,550	8400 18,100	*8100 *17,400	5650 12,200			*6650 *14,600	4700 10,400	6950 280
-4500 mm -180 in	kg lb			*12 300 *26,400	*12 300 *26,400	*8850 *18,850	8650 18,600					*6700 *14,750	6400 14,450	5600 220



ISO 10567



*Indicates that the load is limited by hydraulic lifting capacity rather than tipping load. The above loads are in compliance with hydraulic excavator lift capacity standard ISO 10567:2007. They do not exceed 87% of hydraulic lifting capacity or 75% of tipping load. Weight of all lifting accessories must be deducted from the above lifting capacities. Lifting capacities are based on the machine standing on a firm, uniform supporting surface. The use of a work tool attachment point to handle/lift objects, could affect the machine lift performance.









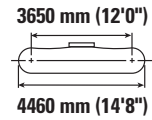
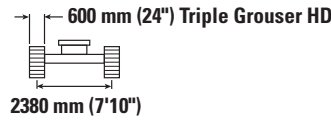
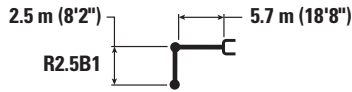

Lift capacity stays with ±5% for all available track shoes.

Always refer to the appropriate Operation and Maintenance Manual for specific product information.

323F L Hydraulic Excavator Specifications









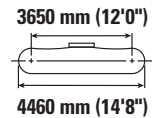
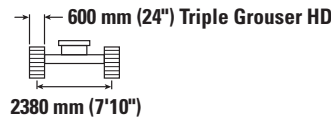
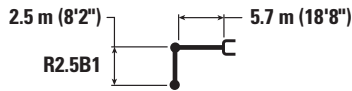

Reach Boom Lift Capacities – Heavy Counterweight: 5.35 mt (11,794 lb) – without Bucket



		3000 mm/120 in		4500 mm/180 in		6000 mm/240 in		7500 mm/300 in				mm in
												
7500 mm 300 in	kg lb									*4750 *10,500	*4750 *10,500	5600 220
6000 mm 240 in	kg lb					*5300 *11,600	*5300 *11,600			*4350 *9,550	*4350 *9,550	6830 270
4500 mm 180 in	kg lb			*6650 *14,350	*6650 *14,350	*5700 *12,450	*5700 *12,450	*4800 4450		*4250 *9,350	*4250 *9,350	7570 300
3000 mm 120 in	kg lb			*8400 *18,000	*8400 *18,000	*6450 *14,000	6050 13,000	*5600 *12,250	4400 9,450	*4350 *9,550	4000 8,850	7960 320
1500 mm 60 in	kg lb			*9900 *21,300	8600 18,550	*7250 *15,650	5800 12,500	*5950 *12,900	4300 9,250	*4650 *10,200	3900 8,550	8050 320
0 mm 0 in	kg lb			*10 550 *22,850	8400 18,050	*7700 *16,700	5650 12,200	*6150 *13,300	4250 9,100	*5200 *11,400	4000 8,750	7860 310
-1500 mm -60 in	kg lb	*11 300 *25,750	*11 300 *25,750	*10 400 *22,550	8350 18,000	*7750 *16,750	5600 12,100			*6100 *13,400	4350 9,550	7350 290
-3000 mm -120 in	kg lb	*13 050 *28,300	*13 050 *28,300	*9500 *20,500	8450 18,250	*7000 *15,000	5700 12,300			*6250 *13,800	5200 11,550	6470 260
-4500 mm -180 in	kg lb			*7050 *14,800	*7050 *14,800					*6150 *13,400	*6150 *13,400	4980 200

Reach Boom Lift Capacities – Heavy Counterweight: 5.35 mt (11,794 lb) – without Bucket – Heavy Lift On



		3000 mm/120 in		4500 mm/180 in		6000 mm/240 in		7500 mm/300 in				mm in
												
7500 mm 300 in	kg lb									*5150 *11,450	*5150 *11,450	5600 220
6000 mm 240 in	kg lb					*5850 *12,800	*5850 *12,800			*4750 *10,450	*4750 *10,450	6830 270
4500 mm 180 in	kg lb			*7350 *15,800	*7350 *15,800	*6300 *13,700	6250 13,500	*5200 4450		*4650 *10,200	4400 9,750	7570 300
3000 mm 120 in	kg lb			*9250 *19,850	9050 19,550	*7150 *15,450	6050 13,000	*6200 *13,550	4400 9,450	*4750 *10,450	4000 8,850	7960 320
1500 mm 60 in	kg lb			*10 900 *23,500	8600 18,550	*8000 *17,300	5800 12,500	6500 14,000	4300 9,250	*5050 *11,100	3900 8,550	8050 320
0 mm 0 in	kg lb			*11 650 *25,200	8400 18,050	*8550 *18,450	5650 12,200	6400 13,850	4250 9,100	*5650 *12,450	4000 8,750	7860 310
-1500 mm -60 in	kg lb	*12 000 *27,250	*12 000 *27,250	*11 500 *24,900	8350 18,000	*8550 *18,500	5600 12,100			6600 14,550	4350 9,550	7350 290
-3000 mm -120 in	kg lb	*14 450 *31,300	*14 450 *31,300	*10 500 *22,650	8450 18,250	*7750 *16,600	5700 12,300			*6950 *15,250	5200 11,550	6470 260
-4500 mm -180 in	kg lb			*7850 *16,450	*7850 *16,450					*6800 *14,900	*6800 *14,900	4980 200



ISO 10567



*Indicates that the load is limited by hydraulic lifting capacity rather than tipping load. The above loads are in compliance with hydraulic excavator lift capacity standard ISO 10567:2007. They do not exceed 87% of hydraulic lifting capacity or 75% of tipping load. Weight of all lifting accessories must be deducted from the above lifting capacities. Lifting capacities are based on the machine standing on a firm, uniform supporting surface. The use of a work tool attachment point to handle/lift objects, could affect the machine lift performance.

Lift capacity stays with ±5% for all available track shoes.

Always refer to the appropriate Operation and Maintenance Manual for specific product information.

323F L Hydraulic Excavator Specifications

Super Long Reach Boom Lift Capacities – Counterweight: 4.7 mt (10,360 lb) – without Bucket

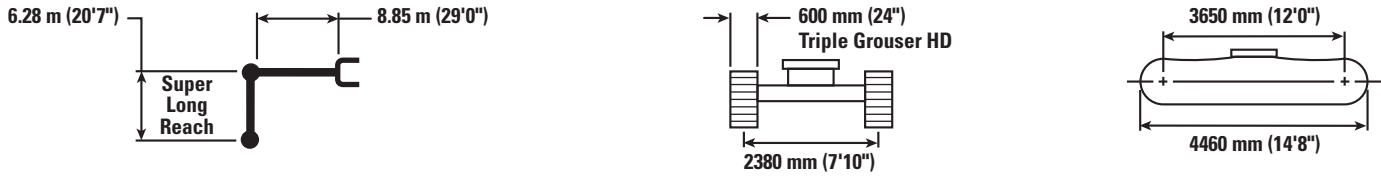

Reach mm in	Unit	1500 mm/60 in		3000 mm/120 in		4500 mm/180 in		6000 mm/240 in		7500 mm/300 in		mm in		
		kg lb	kg lb	kg lb	kg lb	kg lb	kg lb	kg lb	kg lb	kg lb	kg lb	kg lb	kg lb	
12 000 mm 480 in	kg lb											*1250 *2,800	*1250 *2,800	10 350 400
10 500 mm 420 in	kg lb											*1150 *2,600	*1150 *2,600	11 660 460
9000 mm 360 in	kg lb											*1100 *2,450	*1100 *2,450	12 660 500
7500 mm 300 in	kg lb											*1100 *2,400	*1100 *2,400	13 410 530
6000 mm 240 in	kg lb											*1100 *2,400	*1100 *2,400	13 970 550
4500 mm 180 in	kg lb											*1100 *2,400	*1100 *2,400	14 340 570
3000 mm 120 in	kg lb			*4700 *11,850	*4700 *11,850	*6050 *12,950	*6050 *12,950	*4450 *9,600	*4450 *9,600	*3650 *7,850	*3650 *7,850	*1150 *2,500	*1150 *2,500	14 550 580
1500 mm 60 in	kg lb					*6750 *16,000	6750 15,000	*5300 *11,350	4800 10,300	*4150 *8,900	3550 7,650	*1200 *2,600	*1200 *2,600	14 600 580
0 mm 0 in	kg lb			*2000 *4,550	*2000 *4,550	*4650 *10,700	*4650 *10,700	*5900 *12,750	4350 9,350	*4550 *9,850	3250 7,000	*1250 *2,750	1200 2,650	14 490 570
-1500 mm -60 in	kg lb	*2050 *4,550	*2050 *4,550	*2700 *6,050	*2700 *6,050	*4650 *10,500	*4650 *10,500	*6300 *13,650	4100 8,750	*4850 *10,500	3050 6,600	*1350 *2,950	1250 2,700	14 230 560
-3000 mm -120 in	kg lb	*2850 *6,350	*2850 *6,350	*3500 *7,850	*3500 *7,850	*5200 *11,750	*5200 *11,750	*6450 *14,000	3950 8,500	5000 10,750	2950 6,300	*1500 *3,300	1300 2,800	13 790 550
-4500 mm -180 in	kg lb	*3650 *8,150	*3650 *8,150	*4400 *9,900	*4400 *9,900	*6050 *13,700	5900 12,750	*6450 *13,900	3900 8,400	4950 10,650	2900 6,200	*1700 *3,750	1350 3,000	13 170 520
-6000 mm -240 in	kg lb	*4550 *10,100	*4550 *10,100	*5400 *12,150	*5400 *12,150	*7200 *16,350	6050 12,950	*6200 *13,350	3950 8,500	*4950 *10,600	2900 6,250	*2000 *4,450	1500 3,350	12 340 490
-7500 mm -300 in	kg lb	*5500 *12,250	*5500 *12,250	*6550 *14,800	*6550 *14,800	*7350 *15,800	6200 13,400	*5700 *12,250	4050 8,750	*4600 *9,850	2950 6,400	*2500 *5,650	1800 3,950	11 240 440
-9000 mm -360 in	kg lb			*7950 *17,650	*7950 *17,650	*6200 *13,200	*6200 *13,200	*4900 *10,400	4250 9,150	*3950 *8,350	3100 6,750	*2700 *5,950	2250 5,050	9800 380



ISO 10567



*Indicates that the load is limited by hydraulic lifting capacity rather than tipping load. The above loads are in compliance with hydraulic excavator lift capacity standard ISO 10567:2007. They do not exceed 87% of hydraulic lifting capacity or 75% of tipping load. Weight of all lifting accessories must be deducted from the above lifting capacities. Lifting capacities are based on the machine standing on a firm, uniform supporting surface. The use of a work tool attachment point to handle/lift objects, could affect the machine lift performance.

Lift capacity stays with ±5% for all available track shoes.

Always refer to the appropriate Operation and Maintenance Manual for specific product information.

323F L Hydraulic Excavator Specifications

Work Tool Offering Guide* – ADSD-N

Boom Type	Reach Boom			
Stick Size	HD R2.92 (9'6")	HD R2.92 (9'6")	HD R2.92 – TR (9'6")	HD R3.86 (12'10")
Undercarriage/Counterweight	L/4.1 mt (9,039 lb) Standard CTWT			
Hydraulic Hammer	H120Es H130Es	H120Es H130Es	H120Es H130Es	H120Es** H130Es***
Multi-Processor	MP318 CC Jaw MP318 D Jaw MP318 P Jaw** MP318 U Jaw MP318 S Jaw	MP318 CC Jaw MP318 D Jaw MP318 P Jaw** MP318 U Jaw MP318 S Jaw	MP318 CC Jaw MP318 D Jaw MP318 P Jaw** MP318 U Jaw** MP318 S Jaw	MP318 S Jaw***
Crusher	P315	P315	P315	
Pulverizer	P215	P215	P215	P215***
Demolition and Sorting Grapple	G315B-D/R G315B-WH	G315B-D/R G315B-WH	G315B-D/R G315B-WH	
Mobile Scrap and Demolition Shear	S320B** S325B## S340B##	S320B** S325B ## S340B ##	S320B*** S325B## S340B##	S325B## S340B##
Compactor (Vibratory Plate)	CVP110	CVP110	CVP110	CVP110
Orange Peel Grapple				
Trash Grapple				
Thumbs				
Rakes				
Pin Grabber Coupler				Cat-PG
Dedicated Quick Coupler				

These work tools are available for the 323F L.
Consult your Cat dealer for proper match.

*Offerings not available in all areas. Matches are dependent on excavator configurations. Consult your Cat dealer to determine what is offered in your area and for proper work tool match.

**Pin-on or Dedicated Quick Coupler.

***Pin-on only.

##Boom Mount.

Demolition and Sorting Grapple: D-Demolition shells, R-Recycling shells, WH-Waste Handling shells.

323F L Hydraulic Excavator Specifications

Work Tool Offering Guide* – ANZ

Boom Type	Reach Boom and HD Reach Boom	
	R2.5 (8'2")	R2.9 (9'6")
Undercarriage/Counterweight	L/5.35 mt (11,794 lb) CTWT	
Hydraulic Hammer	H120Es H130Es	H120Es H130Es
Multi-Processor	MP318 CC Jaw MP318 D Jaw MP318 P Jaw MP318 U Jaw MP318 S Jaw	MP318 CC Jaw MP318 D Jaw MP318 P Jaw MP318 U Jaw MP318 S Jaw
Crusher	P315	P315
Pulverizer	P215	P215
Demolition and Sorting Grapple	G315B-D/R G315B-WH G315B-D/R fixed CAN G320B-D/R	G315B-D/R G315B-WH G315B-D/R fixed CAN G320B-D/R**
Scrap and Demolition Shear	S320B S325B## S340B# ##	S320B S325B## S340B# ##
Compactor (Vibratory Plate)	CVP110	CVP110
Orange Peel Grapple		
Trash Grapple		
Thumbs		
Rakes		
Pin Grabber Coupler	Cat-PG	

These work tools are available for the 323F L.
Consult your Cat dealer for proper match.

*Offerings not available in all areas. Matches are dependent on excavator configurations. Consult your Cat dealer to determine what is offered in your area and for proper work tool match.

**Pin-on only.

#Work over the front only.

##Boom Mount.

323F L Hydraulic Excavator Specifications

Bucket Specifications and Compatibility – ADSD-N

	Linkage	Width		Capacity		Weight		Fill %	790 mm (31") Triple Grouser					
		mm	in	m ³	yd ³	kg	lb		4.1 mt (11,794 lb) Counter-weight	5.35 mt (11,794 lb) Counterweight			4.7 mt (10,360 lb) Counter-weight	
									Reach	HD Reach			SLR	
										R2.9 (9'6")	R2.9 (9'6")	R2.9 (9'6") TR		R3.9 (12'10")
Without Quick Coupler														
General Duty (GDC)	B	600	24	0.55	0.72	618	1,363	100%	●	●	●	●		
	B	750	30	0.75	0.98	710	1,566	100%	●	●	●	●		
	B	900	36	0.95	1.24	786	1,733	100%	●	●	●	●		
	B	1050	42	1.16	1.52	847	1,867	100%	●	●	●	●		
	B	1200	48	1.38	1.80	925	2,038	100%	⊙	●	●	⊙		
	B	1350	54	1.59	2.08	1002	2,209	100%	X	X	X	X		
Heavy Duty (HD)	B	600	24	0.46	0.61	649	1,430	100%	●	●	●	●		
	B	750	30	0.64	0.84	747	1,647	100%	●	●	●	●		
	B	900	36	0.81	1.06	825	1,818	100%	●	●	●	●		
	B	1050	42	1.00	1.31	879	1,937	100%	●	●	●	●		
	B	1200	48	1.19	1.56	970	2,138	100%	●	●	●	⊙		
	B	1350	54	1.38	1.81	1051	2,316	100%	X	X	X	X		
Severe Duty (SD)	B	600	24	0.46	0.61	693	1,527	90%	●	●	●	●		
	B	750	30	0.64	0.84	801	1,765	90%	●	●	●	●		
	B	900	36	0.81	1.06	887	1,955	90%	●	●	●	●		
	B	1050	42	1.00	1.31	962	2,121	90%	●	●	●	●		
	B	1200	48	1.19	1.56	1051	2,316	90%	●	●	●	●		
General Duty (GD)	A	900	36	0.53	0.69	403	888	100%					◇	
Ditch Cleaning (DC)	A	1200	48	0.57	0.74	388	855	100%					◇	
Maximum load pin-on (payload + bucket)									kg	3391	3974	3754	3279	969
									lb	7,474	8,759	8,274	7,227	2,136
With Pin Grabber Coupler														
General Duty (GDC)	B	600	24	0.55	0.72	618	1,363	100%	●	●	●	●		
	B	750	30	0.75	0.98	710	1,566	100%	●	●	●	●		
	B	900	36	0.95	1.24	786	1,733	100%	●	●	●	●		
	B	1050	42	1.16	1.52	847	1,867	100%	⊙	●	●	⊙		
	B	1200	48	1.38	1.80	925	2,038	100%	⊖	⊙	⊙	⊖		
	B	1350	54	1.59	2.08	1002	2,209	100%	○	⊖	⊖	○		
Heavy Duty (HD)	B	600	24	0.46	0.61	649	1,430	100%	●	●	●	●		
	B	750	30	0.64	0.84	747	1,647	100%	●	●	●	●		
	B	900	36	0.81	1.06	825	1,818	100%	●	●	●	●		
	B	1050	42	1.00	1.31	879	1,937	100%	●	●	●	⊙		
	B	1200	48	1.19	1.56	970	2,138	100%	⊖	●	⊙	⊖		
	B	1350	54	1.38	1.81	1051	2,316	100%	○	⊙	⊖	○		
Severe Duty (SD)	B	600	24	0.46	0.61	693	1,527	90%	●	●	●	●		
	B	750	30	0.64	0.84	801	1,765	90%	●	●	●	●		
	B	900	36	0.81	1.06	887	1,955	90%	●	●	●	●		
	B	1050	42	1.00	1.31	962	2,121	90%	●	●	●	●		
	B	1200	48	1.19	1.56	1051	2,316	90%	⊙	●	●	⊖		
Maximum load pin-on (payload + bucket)									kg	2981	3564	3344	2869	
									lb	6,571	7,856	7,371	6,324	

The above loads are in compliance with hydraulic excavator standard EN474, they do not exceed 87% of hydraulic lifting capacity or 75% of tipping capacity with front linkage fully extended at ground line with bucket curled.

Capacity based on ISO 7451.

Bucket weight with General Duty tips.

Maximum Material Density:

- 2100 kg/m³ (3,500 lb/yd³)
- ⊙ 1800 kg/m³ (3,000 lb/yd³)
- ⊖ 1500 kg/m³ (2,500 lb/yd³)
- 1200 kg/m³ (2,000 lb/yd³)
- ◇ 900 kg/m³ (1,500 lb/yd³)
- X Not allowed per structures matching guide

Caterpillar recommends using appropriate work tools to maximize the value customers receive from our products. Use of work tools, including buckets, which are outside of Caterpillar's recommendations or specifications for weight, dimensions, flows, pressures, etc. may result in less-than-optimal performance, including but not limited to reductions in production, stability, reliability, and component durability. Improper use of a work tool resulting in sweeping, prying, twisting and/or catching of heavy loads will reduce the life of the boom and stick.

323F L Hydraulic Excavator Specifications

Bucket Specifications and Compatibility – ANZ

	Linkage	Width		Capacity		Weight		Fill	600 mm (24") Triple Grouser		
									5.35 mt (11,794 lb) Counterweight		4.7 mt (10,360 lb) Counterweight
		mm	in	m ³	yd ³	kg	lb	%	Reach		SLR
									R2.5 (8'2")	R2.9 (9'6")	R6.3 (20'7")
Without Quick Coupler											
General Duty (GDC)	B	600	24	0.46	0.61	546	1,204	100%	●	●	
	B	1050	42	1.00	1.31	731	1,611	100%	●	●	
	B	1200	48	1.19	1.56	799	1,761	100%	●	●	
Heavy Duty (HD)	B	1050	42	1.00	1.31	879	1,937	100%	●	●	
	B	1200	48	1.19	1.56	970	2,138	100%	●	●	
	B	1350	54	1.38	1.81	1051	2,316	100%	X	X	X
Severe Duty (SD)	B	1050	42	1.00	1.31	962	2,121	90%	●	●	
General Duty (GD)	A	900	36	0.53	0.69	403	888	100%			◇
Ditch Cleaning (DC)	A	1200	48	0.57	0.74	388	855	100%			◇
Maximum load pin-on (payload + bucket)								kg	4160	3878	917
								lb	9,169	8,547	2,021
With Pin Grabber Coupler											
General Duty (GDC)	B	600	24	0.46	0.61	546	1,204	100%	●	●	
	B	1050	42	1.00	1.31	731	1,611	100%	●	●	
	B	1200	48	1.19	1.56	799	1,761	100%	●	●	
Heavy Duty (HD)	B	1050	42	1.00	1.31	879	1,937	100%	●	●	
	B	1200	48	1.19	1.56	970	2,138	100%	●	●	
	B	1350	54	1.38	1.81	1051	2,316	100%	⊙	⊙	
Severe Duty (SD)	B	1050	42	1.00	1.31	962	2,121	90%	●	●	
Maximum load pin-on (payload + bucket)								kg	3750	3468	507
								lb	8,266	7,644	1,118

The above loads are in compliance with hydraulic excavator standard EN474, they do not exceed 87% of hydraulic lifting capacity or 75% of tipping capacity with front linkage fully extended at ground line with bucket curled.

Capacity based on ISO 7451.

Bucket weight with General Duty tips.

Maximum Material Density:

- 2100 kg/m³ (3,500 lb/yd³)
- ⊙ 1800 kg/m³ (3,000 lb/yd³)
- ◇ 900 kg/m³ (1,500 lb/yd³)
- X Not allowed per structures matching guide

Caterpillar recommends using appropriate work tools to maximize the value customers receive from our products. Use of work tools, including buckets, which are outside of Caterpillar's recommendations or specifications for weight, dimensions, flows, pressures, etc. may result in less-than-optimal performance, including but not limited to reductions in production, stability, reliability, and component durability. Improper use of a work tool resulting in sweeping, prying, twisting and/or catching of heavy loads will reduce the life of the boom and stick.

323F L Standard Equipment

Standard Equipment

Standard equipment may vary. Consult your Cat dealer for details.

ENGINE

- C7.1 ACERT meets Tier 4 Final and Stage IV emission standards
- Three selectable power modes
 - HP, STD and ECO
- Variable-speed fan with viscous clutch
- One-touch low idle with automatic engine speed control
- Automatic engine idle shutdown
- Three-stage fuel filtration system with water separator and indicator
- 4600 m (15,090 ft) altitude capability with derate from 3000 m (9,840 ft)
- 52° C (126° F) high-ambient cooling capacity with derate from 48° C (118° F)
- 115 amp alternator
- Radial seal air filter with double filter element
- Electric fuel priming pump
- Capability of using biodiesel fuel (up to B20)
- Starting kit for –18° C (0° F)

HYDRAULICS

- Electric boom regeneration circuit
- Stick regeneration circuit
- One-touch lifting mode
- Automatic two-speed travel
- Boom and stick drift reduction valve
- Reverse swing damping valve
- High-performance hydraulic return filter
- Canada compliant accumulator
- Fine swing control

CAB

- Sound suppressed ROPS cab with viscous mount
- Openable skylight as emergency exit
- Openable laminated front upper windshield with assist device
- Removable tempered lower windshield with in-cab storage bracket
- High back seat with air suspension, seat heater and head rest
- Fully adjustable seat, console and armrest
- 51 mm (2") width seat belt
- Full graphic 7 inch LCD monitor with distortion-free rearview camera picture
- Automatic bi-level air conditioner with pressurized function
- Joystick with modulation switch (one modulation switch and three on/off switches per one joystick)
- Radial wiper
- 24V AM/FM radio (includes auxiliary input)
- 12V × 2 power supply with sockets (maximum 10 amp)
- Washable floor mat
- Interior utilities
 - Interior lighting
 - Coat hook
 - Beverage holder
 - Literature holder
 - Document holding space
 - Cab rear storage compartment

UNDERCARRIAGE & STRUCTURES

- HD track rollers
- Segmented (two-piece) track guiding guard
- Grease lubricated track link
- Tie down points on base frame
- HD bottom guard
- Swivel guard

ELECTRICAL

- Maintenance-free battery
- Centralized electrical disconnect switch
- Cat Product Link
- Programmable time-delay halogen working lights
 - Storage box mounted (one)
 - Cab mounted (two)
 - Boom mounted LH and RH (two)

SERVICE & MAINTENANCE

- Engine oil, fuel, and hydraulic oil filters grouped for ease of maintenance
- Sampling ports for Scheduled Oil Sampling (S·O·SSM)
- Tilt-up air-to-air aftercooler (ATAAC) and swing-out type A/C condenser for easy maintenance

SAFETY & SECURITY

- Rearview camera with three mirrors and one additional cab mirror
- RH hand rail and hand hold
- Bolt-free service platform with anti-skid plate
- Neutral lever (lock out) for all controls
- Ground-level accessible secondary engine shutoff switch in cab
- Signaling/warning horn
- Safety hammer for cab evacuation

TECHNOLOGY

- Cat Grade Control Depth and Slope
 - except for R3.9 (12'10") stick and SLR front

Optional Equipment

Optional equipment may vary. Consult your Cat dealer for details.

ENGINE

- Air precleaner

HYDRAULICS

- Tool control
- Medium-pressure circuit
- Quick coupler circuit for Cat Pin Grabber

CAB

- Control pattern quick changer
- Straight travel pedal
- Sun screen roll type for 70/30 window

ELECTRICAL

- Pre-wired harness for beacon (ANZ only)

UNDERCARRIAGE & STRUCTURES

ADSD-N Configurations and Options

- 4100 kg (9,039 lb) standard counterweight
- 4700 kg (10,360 lb) extra counterweight for Super Long Reach
- 5350 kg (11,794 lb) counterweight for heavy configuration
- 600 mm (24") single grouser shoe
- 790 mm (31") triple grouser heavy duty shoe
- 790 mm (31") triple grouser shoe
- HD and standard Reach 5.7 m (18'8") boom
 - R3.9 (12'10") stick
 - Thumb-ready 2.9 m (9'6") stick
 - 2.9 m (9'6") stick
- Super Long Reach 8.85 m (29'0") boom
 - Super Long Reach 6.28 m (20'7") stick
- Bucket linkage
- Bucket linkage for SLR

ANZ Configurations and Options

- 4700 kg (10,360 lb) extra counterweight for Super Long Reach
- 5350 kg (11,794 lb) counterweight for heavy configuration
- 600 mm (24") triple grouser heavy duty shoe
- 700 mm (28") triple grouser heavy duty shoe
- 790 mm (31") triple grouser heavy duty shoe
- HD Reach 5.7 m (18'8") boom
 - 2.9 m (9'6") stick
 - 2.5 m (8'2") stick
- Super Long Reach 8.85 m (29'0") boom
 - Super Long Reach 6.28 m (20'7") stick
- Bucket linkage
- Bucket linkage for SLR

SERVICE & MAINTENANCE

- PM (Preventative Maintenance) ready (QuickEvac)

SAFETY & SECURITY

- Boom lowering control device and stick lowering check valve
- Travel alarm

DEALER INSTALLED KITS AND ATTACHMENTS

- Cat Grade with ASSIST (ADSD-N only)
- Cold weather field installation retrofit kit package (ADSD-N only)
- Rain protector for front windshield
- Seat belt, retractable (76 mm/3" width)
- FOGS retrofit kit package
- Mesh for front guard retrofit kit package
- Mesh guard, lower half front
- Precleaner for air cleaner
- Security system (MSS)
- DEF Tank guard
- Side rubber bumper

For more complete information on Cat products, dealer services, and industry solutions, visit us on the web at www.cat.com

AEHQ7833
(ADSD-N/ANZ)

© 2016 Caterpillar
All rights reserved

Materials and specifications are subject to change without notice. Featured machines in photos may include additional equipment. See your Cat dealer for available options.

CAT, CATERPILLAR, SAFETY.CAT.COM, their respective logos, "Caterpillar Yellow" and the "Power Edge" trade dress, as well as corporate and product identity used herein, are trademarks of Caterpillar and may not be used without permission.

VisionLink is a trademark of Trimble Navigation Limited, registered in the United States and in other countries.

